

Dura-Craft, Inc.

P.O. Box 438 • Newberg, Oregon 97132
(503) 538-3136

Assembly Instruction

VH-600 VICTORIAN MINIATURE HOUSE KIT

FINISHED SIZE 21" x 47" x 40"

SCALE: 1":1'



Copyright 1980

Rev. 4-10-87

PATENTS PENDING

VH-600 VICTORIAN MINIATURE HOUSE KIT

Congratulations on selecting a miniature house kit manufactured by Dura-Craft, Inc., the leader in the industry.

All pine parts used in our kits are manufactured from the finest kiln dried Ponderosa Pine. We pride ourselves on our high quality and workmanship. Each piece is graded and sorted at several different stages to ensure that you receive the finest quality.

The houses manufactured by Dura-Craft are not modeled after any specific existing houses. Rather they are composites of several different houses, to give you what we feel is a true and accurate representation of the houses of

their style and era.

A Dura-Craft miniature house is a complete kit. This means that you do not have to purchase separately items such as siding, window glass, and split cedar shakes, which are a basic part of a house. Your finished house will be ready for painting, wallpapering, and decorating. Dura-Craft does not sell the materials for decorating; however, they should be available through the store where you bought your kit.

Your finished house will be of heirloom quality, of which you will be justly proud, if ample time and care are used in its construction and finishing.

GENERAL INSTRUCTIONS

There are several construction tips that will help you avoid some problems when you build your miniature house.

An important thing to keep in mind about the kit parts: First, they are made of wood. Wood shrinks and expands according to the humidity. We have found that the siding is most sensitive to dimension changes due to humidity. All siding used in Dura-Craft miniature houses is made from the finest kiln dried Ponderosa Pine. However, as a result of changes in siding dimensions brought on by humidity changes, when a wall is assembled with a water base glue, some swelling will occur. Wall panels should be left in a warm dry room at least 48 hours before corner posts are attached. This will prevent walls from cracking. At no time should the house be placed in a cold damp area.

If there is a minor cracking problem, there is a simple solution. A thick bead of white glue should be run into the gap. Wipe off any excess glue and allow to dry. If necessary, repeat this step until the gap is filled. When the house is painted, there will be no evidence of the gap. We recommend a good quality OIL base paint be applied on any siding to be painted.

Your Dura-Craft miniature house has been designed so

that you can assemble it with a minimum of difficulty. Some steps require that careful attention be paid to using the correct part.

The kit has been packaged in a way that should assure that all parts are present. The major parts such as siding are easily identified. Other parts will be identified as you go along checking the parts.

There are several steps that must be followed to make the assembly of your house easier. The first is to read through the instructions carefully to get a feeling for the assembly process. Next, using the parts list and parts drawings, check the parts and group them according to the categories used on the parts list. As you do this, you will become familiar with the parts. Also, if any parts are missing or damaged, they can be replaced by Dura-Craft quickly, so that your assembly process will not be held up. Please refer to the missing parts and broken parts order form.

Wall panels do not come assembled in the kit. Follow instructions to assemble wall panels.

NOTE: For shortages or broken parts write directly to Dura-Craft, Inc. for replacement, using the form on the last page of this manual.

SUBASSEMBLY NO. 1 WALL PANELS

1. Prepare your tools and materials. You will need the following items to complete this assembly:

framing square
ruler or tape measure
pencil
several large books
a dispenser of white woodworking glue
a roll of waxed paper
masking tape

2. Locate the parts. You will need the following parts:

1-2 siding 12 pieces
1-3 siding 28 pieces
1-4 siding 30 pieces
1-5 siding 17 pieces
1-6 siding 39 pieces
1-8 siding 4 pieces
1-9 siding 8 pieces
1-11 siding 30 pieces
1-16 siding 6 pieces
1-17 siding 9 pieces
1-28 siding 6 pieces

3. Prepare the parts for assembly. Finish sand the wood surfaces to remove splinters and rough spots.

4. Pre-assemble the siding *without* glue. Lay the pieces flat side down, as shown in Figure *1. The tongue is on the top edge of each board.

5. Use the framing square to insure that the ends of the side pieces are properly aligned. Measure the widths of the window and door openings very carefully and make light pencil marks at the top and bottom of each opening. The proper widths of the openings are given in Figure *1.

6. Prepare an area for gluing. You will need a hard flat surface at least three feet by four feet in size. Select a location where the wall panels will not have to be disturbed for several hours after gluing. Tape waxed paper over the entire surface.

7. Use the following technique for gluing the wall panels: Apply a thin bead of glue to the tongue then seat it in the groove. Immediately wipe off any surplus glue that squeezes out, using a *damp-but not wet-cloth*. Assemble the panels flat side down on the waxed paper. The panels should be assembled in sections that can be handled easily, as outlined below.

8. Begin with the ground floor section (the first six layers) of wall panels 1-A—1-L, as shown in Figure *1. Make sure that all parts are arranged in the proper sequence relative to the pencil marks for the door and window openings (Refer to step 4 and 5).

9. Make sure that all joints are tight and that the edges of the walls are square and flush. Place weights on the panels as you finish them. Allow about an hour for the glue to set before moving or adding to the panels.

IMPORTANT: If you must leave the wall panels incomplete for more than two or three hours during this phase of construction, stand them on edge to allow air to circulate around both sides. This will minimize the likelihood of warping.

10. Add the second story section to the wall panels 1-A—1-L, as shown in Figure *1. As before, be sure all parts are arranged in the proper sequence, with all edges square.

11. Be sure all joints are tight, then carefully place weights on the wall assemblies. Allow about an hour for the glue to set before moving the panels.

12. Stand the wall panels on edge to allow air to reach both sides. Let the wall panels dry for 24 hours.

FIG. 1

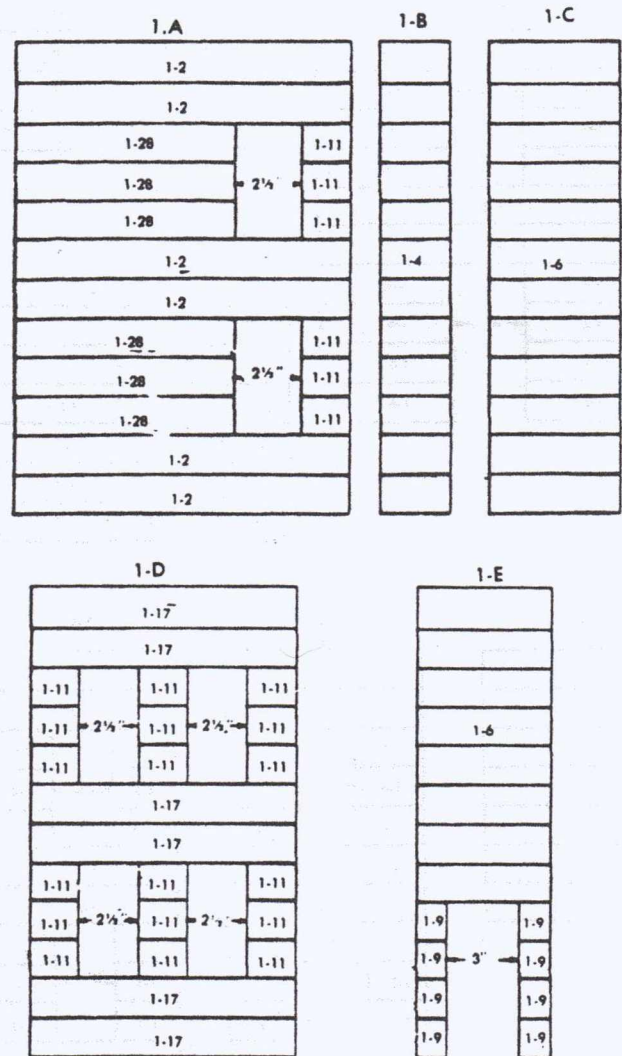

SUBASSEMBLY NO. 2

GABLE ENDS

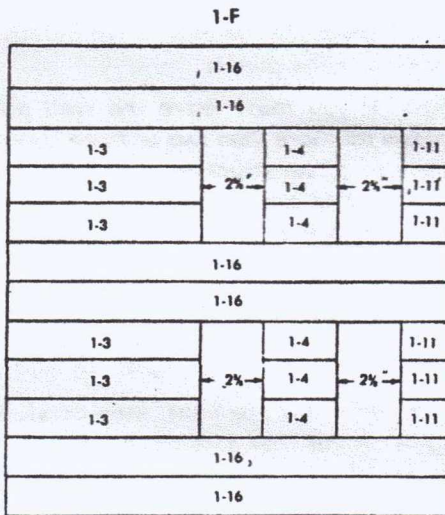

1. Prepare your tools and materials. You will need the following items to complete this assembly:
 1/2 pint sealer
 1-inch paint brush
 thinner
 a framing square
 a pencil
 a dispenser of white working glue
 a roll of waxed paper
 a sharp utility knife
 a ruler or tape measure
2. Locate the parts. You will need the following parts and subassemblies:
 4-36, main gables, 2 pieces
 5-17, shakes (plain)
 5-18, shakes (fancy)
 wall panel 1-A
 wall panel 1-G

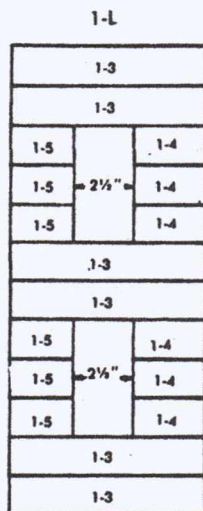
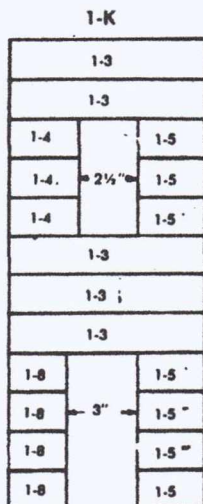
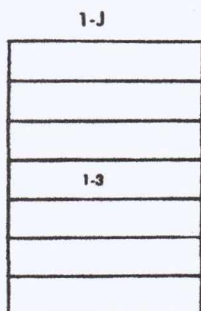
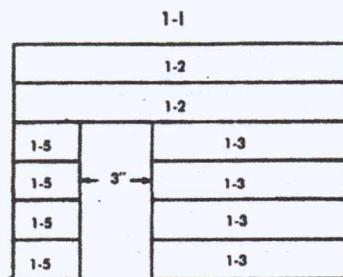
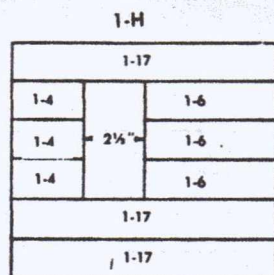
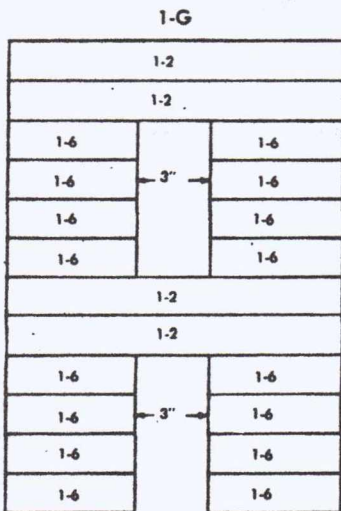

3. Brush a thin coat of sanding sealer onto the rough side of each of the gables. Allow the sealer to dry.
4. Use the utility knife or plane to carefully shave the tongue off the top piece of the siding on each of the wall panels (1-A and 1-G.)
5. Lay the two main gables (part no. 4-36) on the table, rough side facing up. Measure 1 1/4" up from the bottom of the gables and draw a line parallel with the bottom edge Figure *2. Now draw lines at one inch intervals the rest of the way up the gable.
6. Spread out waxed paper on a flat surface. Apply glue to the top edge of wall panel 1-A, then lay it face up on the waxed paper. Lay the gable (part no. 4-36) in position on top of the wall panel. Be sure the gable overhangs equally on each side of the wall panel, as shown in Figure *2. Allow the glue to set.
7. Glue the other gable to wall panel 1-G. As described in step 6. Allow the glue to set.
8. On wall panel 1-A only: Using the first horizontal line as a guide, glue one row of plain shakes (part no. 5-17) over the joints between the gable ends and the wall panels as shown in Figure *3. Apply glue heavily under these shakes. Allow the glue to dry before proceeding.
9. Glue the fancy shakes (part no. 5-18) on to the gable end in the over lapping pattern shown in Figure *3 let the shakes hang over the edges of the gables until the glue has dried.
10. After the glue has thoroughly dried turn the wall panel face down, and use the utility knife to trim the shakes flush with the edge of the gable. Start at the lower corners and cut toward the peak to minimize the chances of splitting the shakes.

FIG. 2

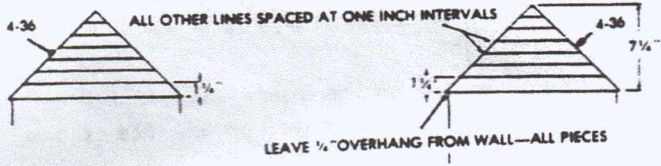

specified or they may interfere with the installation of the corner posts later in the assembly.

5. Glue the floor supports on to wall panels, as shown in Figure *4, so that the upper edges are on the previously drawn lines. Center from side to side, so there is a quarter-inch space between the ends of the floor support and the edges of the wall panels.
6. Glue the gable supports (part 5-47) in place on to the gables on panels 1-A and 1-G. Glue flush with the edges of the gable. Allow to dry.

FIG. 3

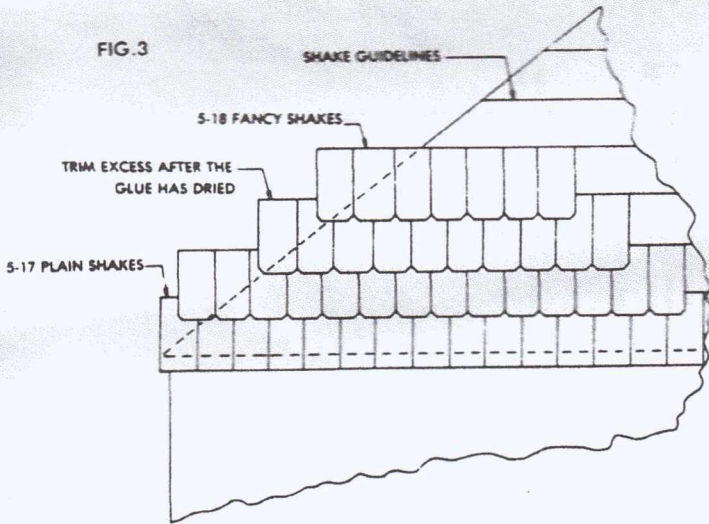

SUBASSEMBLY NO. 3 FLOOR AND GABLE SUPPORTS

1. Prepare your tools and materials. You will need the following items to complete this subassembly:
 - a dispenser of white woodworking glue
 - a utility knife or coping saw
 - a yard stick or tape measure
 - a pencil
 - 100 grade (med.) sandpaper
2. Locate the parts. You will need the following parts and subassemblies:
 - 5-46, floor support
 - 5-47, main gable support, 4 pieces
 - wall panels 1-A through 1-L
3. Lay the wall panels face down. Measure exactly $9\frac{5}{8}$ inches up from the bottom, and draw a pencil line across each panel at that point. Draw another line $19\frac{3}{8}$ inches up from the bottom.
4. Cut the floor support (part 5-46) into pieces of the following lengths
 - 4 pieces $13\frac{1}{2}$ " long for wall panels 1-A, 1-G
 - 2 pieces $2\frac{1}{2}$ " long for wall panel 1-B
 - 2 pieces $4\frac{1}{2}$ " long for wall panel 1-C, 1-E
 - 1 piece $10\frac{1}{2}$ " long for wall panel 1-D
 - 2 pieces 18" long for wall panel 1-F
 - 3 pieces $7\frac{1}{4}$ " long, 1 each for panels 1-J, 1-K, 1-L

FIG. 4

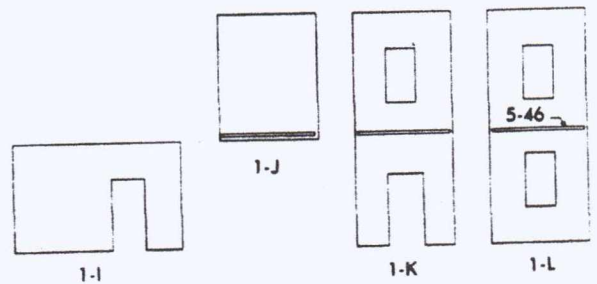
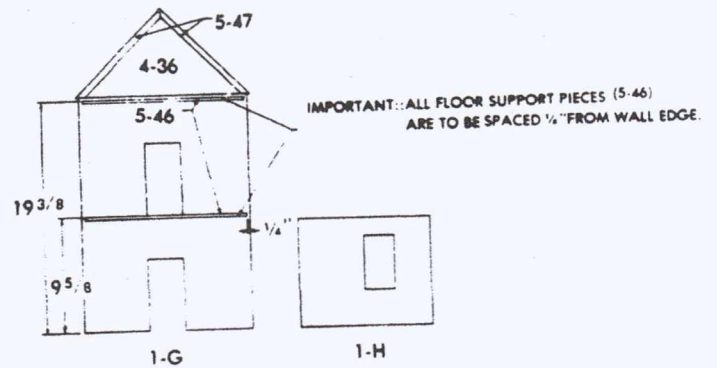
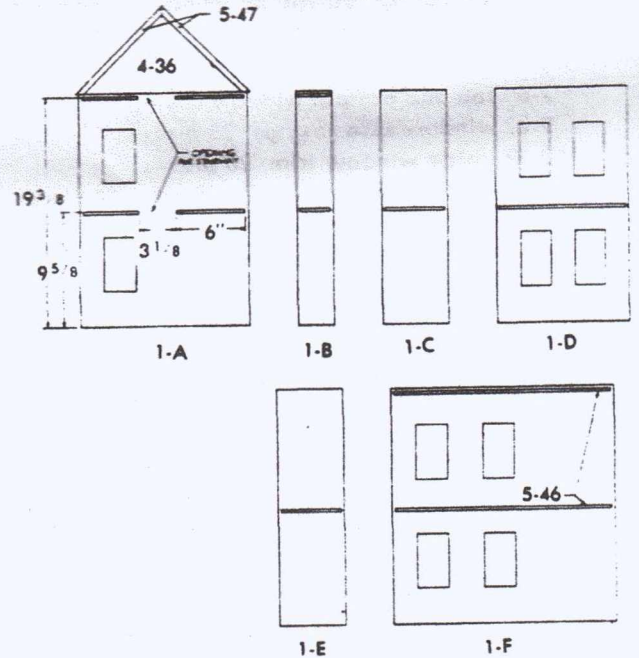

SUBASSEMBLY NO. 4
STANDARD WINDOWS

1. Prepare your tools and materials. You will need the following items to complete this subassembly:
 - a dispenser of white woodworking glue
 - a tube of model airplane cement
 - a utility knife
 - 100 grade (med.) sandpaper
 - a pencil
 - a ruler or tape measure
 - waxed paper
2. Locate the parts: You will be using the following parts and subassemblies.
 - plastic sheets, 2 3/16 X 4 7/16, 14 pieces
 - 2-5 top and bottom window casings
 - 2-22 window side casings, 28 pieces
 - 2-29 inside window trim, 28 pieces
 - 2-30 top and bottom window frame, 28 pieces
 - 5-49 window divider stock
 - 2-33 window caps 14 pieces
3. Using the model airplane cement, glue the top and bottom window frames (part no. 2-30) to the top and bottom of the plastic, seat in the groove, and center from side as shown in Figure *5.
4. Using model airplane cement, glue the window side casings (part no. 2-22) to the sides of the window. Make sure that the side casings (part no. 2-22) contact the top and bottom frames at all four corners. Lay the assemblies face down while the glue dries.
5. Arrange the window assemblies facedown on waxed paper. Use white glue to attach the bottom window casing (2-5). Be sure the casing is centered side to side as shown in Figure *6. Allow the glue to dry before proceeding.
6. Turn the windows face-up and install dividers (part no. 5-49). They may be installed in any pattern to create what ever style of window you desire Figure *6. Cut the window dividers to the required lengths, and glue them to the out side of the windows with model airplane cement.
7. Lay the wall panels (1-A, 1-D, 1-F, 1-H, 1-K, 1-K,) face-up on the table. Apply white woodworking glue to the backs of side and bottom casings, then install the window assemblies in the wall panels. Make sure they are positioned squarely in the openings. Allow the glue to dry before moving the wall panels.
8. After the glue has dried, turn the wall panels over. Glue the inside window trim (part no. 2-29) in place as shown in Figure *7. It should be flush with the window side casings (part 2-22) and should cover the gap between the casings and the wall panel.

9. After the glue has dried install the top and bottom window casings (part no. 2-5) as shown in Figure *7, the ends should over hang evenly left and right.
10. When the glue on the inside window trim and casings is dry, turn the wall panels face-up and glue the window caps (part no. 2-33) in place over the windows as shown in Figure *6.

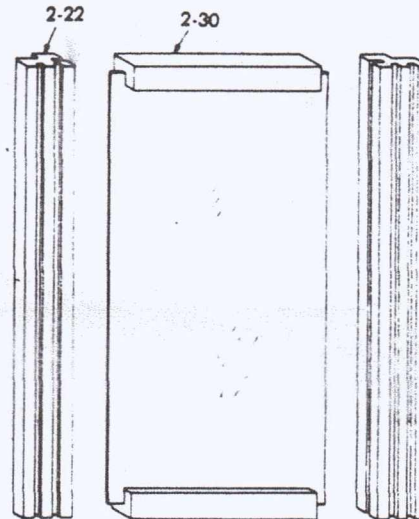

FIG. 5

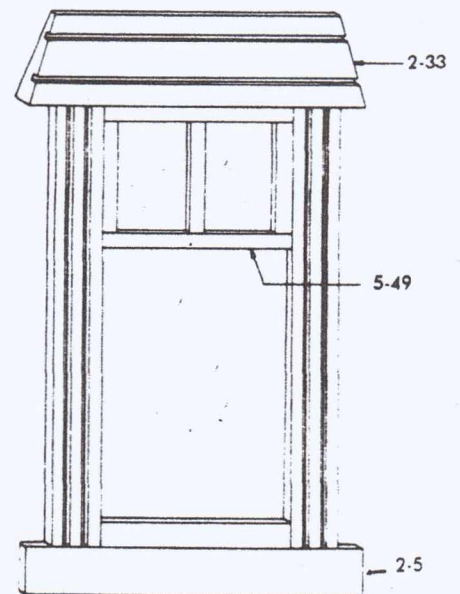

FIG. 6

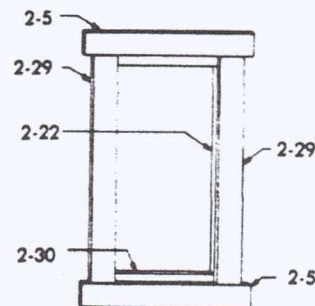

FIG. 7

SUBASSEMBLY NO. 5 STAIRWAYS AND RAILINGS

1. Prepare your tools and materials. You will need the following items to complete this subassembly:
 - a dispenser of white woodworking glue
 - a roll of waxed paper
 - a ruler
 - a pencil
2. Locate the parts. You will need the following parts:
 - 5-70 bannister stock
 - 6-2 bannister posts, 61 pieces
 - 6-13 stairway base, 2 pieces
 - 6-14 steps, 26 pieces
3. Lay the stairway base (part no. 6-13) rough side up, and spread glue evenly over the entire surface.
4. Position the bottom step (part no. 6-14) so the angle-cut side seats in the glue at one end of the stairway base, as shown in Figure *8.
5. Apply glue to the bottom (the smallest side) of the next step, as shown in Figure *8, then lay it in place. It should be in full contact with the stairway base and the bottom step.
6. Install the remaining steps in succession, following the same procedure, spacing them evenly to fill the full length of the stairway base. Be sure all the edges are flush. Allow the glue to set.
7. Cut (8) $3\frac{1}{4}$ inch pieces of bannister stock (part no. 5-70). Lay them out and make pencil marks every half inch, next to the grooves. These mark the locations for the bannister posts.
8. Apply glue to the ends of the bannister posts (part no. 6-2) and install them in the bannisters, as shown in Figure *9, to make four assemblies. Line up the posts with the pencil mark. Be sure the ends of the assemblies are square!!
9. Stand the stairway assembly on edge, on a sheet of waxed paper, as shown in Figure *10.
10. Apply glue to the lower half-inch of the bannister posts, and lay them in position against the steps. Refer to Figure *10.
11. Cut two 12 inch pieces of bannister stock (part no. 5-70). After the glue from step 10 has dried, lift the assembly off the waxed paper. Apply a dab of glue to the end of each post, then install the bannister piece. Its lower end should be flush with the bottom post, and the upper end should overhang about an inch.

FIG. 8

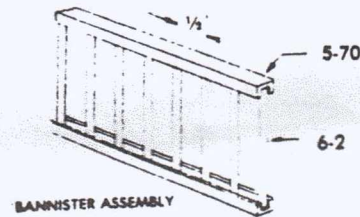
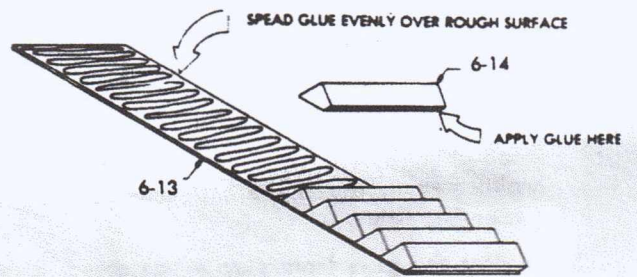
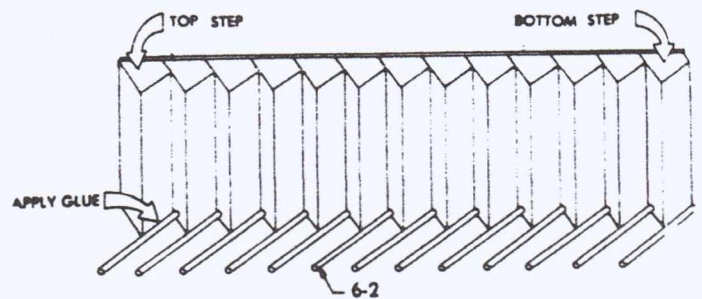

FIG. 9

FIG. 10



SUBASSEMBLY NO. 6 HOUSE BASE

1. Prepare your tools and materials. You will need the following items to complete this subassembly:
 - a dispenser of white woodworking glue
 - a roll of waxed paper
 - masking tape
2. Locate the parts. You will need the following parts:

3-2 base $14\frac{1}{2}$ X $31\frac{1}{2}$,	1 piece
3-3 base $6\frac{1}{2}$ X $31\frac{1}{2}$,	1 piece
3-6 foundation strip $20\frac{1}{4}$,	3 pieces
3-12 base 15 X 21,	1 piece
3-13 foundation strip $23\frac{1}{4}$,	4 pieces

3. Prepare an area for gluing. You will need a hard flat surface at least 21 X 46½" in size. Select a location where the assembly will not have to be disturbed for twelve hours after gluing. Tape waxed paper over the entire surface.
4. Glue the three base pieces (3-2, 3-3, and 3-12) together, as shown in Figure *12-A. Apply the glue heavily to the mating surfaces, then press together firmly.
5. After the glue from step 4 has dried, glue the foundation strip (part no. 3-13) in place, as shown in Figure *12-B.
6. When the glue from step 5 has set, glue the base crossmembers (part no. 3-6) in place as shown in Figure *12-C.

FIG. 12

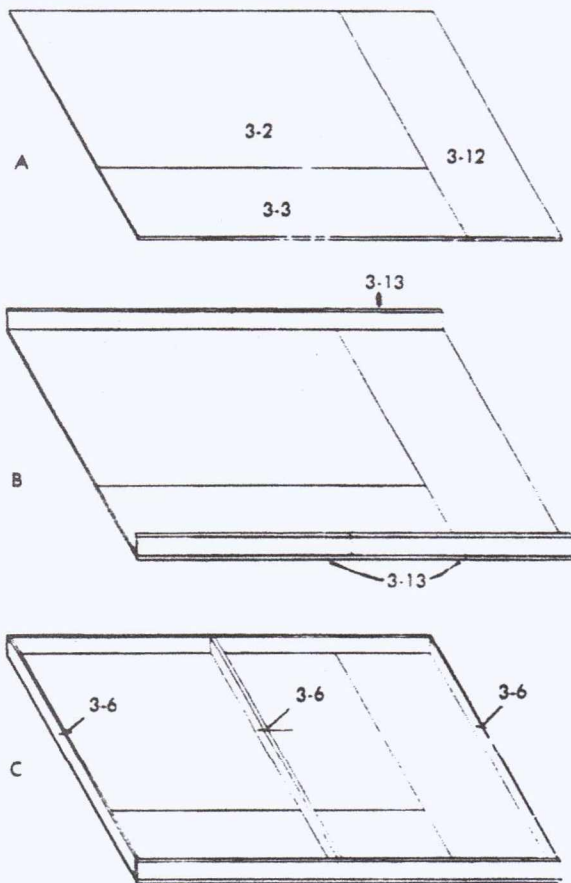

SUBASSEMBLY NO. 7 PORCH, RAILING AND DECK SUPPORTS.

1. Prepare your tools and materials. You will need the following items to complete this subassembly:
 - a dispenser of white woodworking glue
 - masking tape
 - waxed paper
 - a utility knife
 - a ruler or tape measure
 - a coping saw
 - a framing square
 - rubber bands
2. Locate the parts. You will be using the following parts and subassemblies:
 - 5-37 deck support, 5 pieces
 - 5-46 floor support stock
 - 6-4 porch railing stock
 - 6-6 porch railing posts
 - 6-12 decorative gussets
 - wall panels- 1-E, 1-F, 1-G
3. Lay wall panels 1-E, 1-F, 1-G, face up on the table measure up from the bottom of the panels 9¾" and draw a line across the face of the wall panels.
4. Cut floor support stock (part no. 5-46), 5" long, 1 piece, 18" and 1 piece 13½" long. Glue these on wall panels 1-E, 1-F, 1-G, as shown in Figure *13, centered side to side.
5. Cut porch railing stock (part no. 6-4) into pieces of the following lengths:
 - 2 pieces 4" long
 - 2 pieces 5¼" long
 - 2 pieces 12 3/16" long
 - 2 pieces 17 7/8" long
 - 2 pieces 19 7/16" long
 - 2 pieces 21 ½" long
6. Measure and mark each porch railing at approximated 1" intervals, spacing evenly end to end of each set. This marks the center of each porch railing post.
7. Apply glue to the ends of the porch railing posts (part no. 6-6) and install them in the railings. Line up the center of the post with the marks on the railings. Make sure the ends of the assemblies are square.
8. Spread waxed paper over an area large enough to lay out the seven porch railing assemblies shown in Figure *14.
9. Check the ends of the railing assemblies to insure that the top and bottom rails are exactly square with one another. Square them up with sandpaper, if necessary.
10. Apply glue to the ends of the 4" pieces, then lay them on the waxed paper and position two deck supports (part no. 5-37) against them as

shown in Figure *14. Allow the glue to dry.

11. Repeat above procedure to assemble all porch and deck railings.
12. Glue the decorative gussets (part no. 6-12) in place as shown in Figure *14. Make certain that they are flush with the tops of the deck supports. Allow the glue to thoroughly dry before lifting the assemblies from the waxed paper. Handle the assemblies very carefully until they are installed in the house.

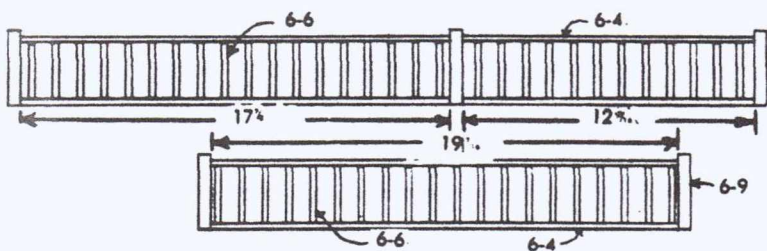
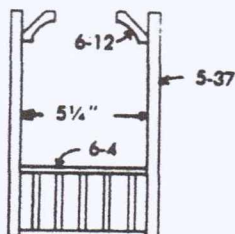
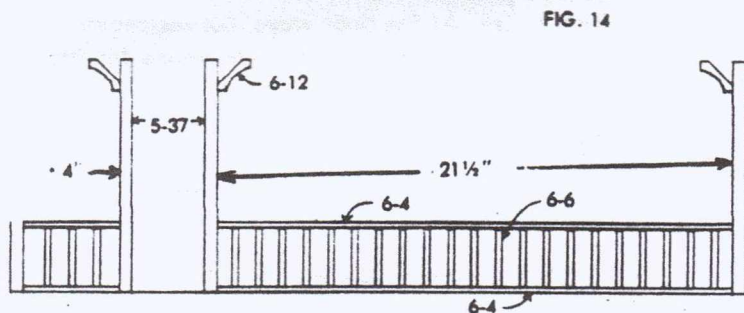
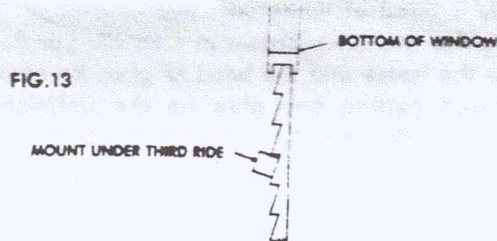

NOTE: ALL PORCH RAILING POSTS ARE SPACED AT 1" CENTER TO CENTER

FINAL ASSEMBLY PART 1 WALLS, FLOOR AND BASE

1. Prepare your tools and materials. You will need the following items to complete this phase:
 - a dispenser of white woodworking glue
 - a pencil
 - "T" pins or straight pins
 - string
 - several large rubber bands
 - a framing square
 - masking tape
 - a coping saw
 - one pint of contact cement
 - a one inch natural fiber paint brush
 - scissors
 - 3/32 nail set (optional)
 - 100 grade (med.) sandpaper
 - 1/2 pint sanding sealer
 - thinner
 - Polyurethane varnish (satin finish)
 - steel wool.
2. Locate the parts. You will be using the following parts and completed subassemblies:
 - wall panels 1-A through 1-L
 - 4-37 2nd. and attic floor
 - 4-39 front wing floor
 - 4-44 tower floor
 - 5-1 corner posts, 4 pieces
 - 5-2 corner posts, 8 pieces
 - 5-3 universal molding stock
 - 5-30 short corner post
 - 5-31 short corner post
 - 5-51 rear floor trim 2 pieces
 - 5-58 tower floor trim
 - Hardwood flooring 1 bundle
 - Base subassembly
3. Cut two 1/4 X 1/4 notches from one edge of wing floor (part 4-39), and two 1/8 X 1/2 notches as shown in Figure *15.
4. Assemble wall panels 1-C, 1-D and 1-E, by applying glue to the grooves in the corner posts (part no. 5-2). Be sure the grooves in the corner posts are all pointed the right direction, as shown in Figure *16. Carefully seat the wall panels all the way into the grooves.
5. Apply a bead of glue to the top surface of the floor supports. Lay the floor (part no. 4-39) in place, smooth side up, and press gently into the glue.
6. Tie strings around the assembly as shown in Figure *16. Use rubber bands to keep the string tight. This will keep the walls pulled in against the floor piece. Stick pins into the wall panels at floor level to wedge the floor down against the floor supports.

7. The glue from all proceeding steps in this sequence must be dry before proceeding. Remove all strings, pins, etc.
 8. Assemble wall panels 1-A, 1-B, 1-F, and 1-G, 1-H, 1-I, 1-J, 1-K, 1-L, as shown in Figure *16-A into the grooves, then tape the corners together on the outside of the house. Before the glue sets, proceed with step 9.
 9. Apply a bead of glue to the top surface of the floor supports. Lay the main floor panels in place smooth side up, and press them gently in to place.
 10. Use string, rubber bands, and pins to hold the house together tightly while the glue dries. Check carefully to insure that all joints are tight and corners square.
 11. Glue the rear floor trim (part no. 5-51, 2 pieces) in place across the rear edges of the two floors.
 12. Repeat above procedure to install tower floor (part no. 4-44) in place. Then glue tower floor trim (part no. 5-58) in place across the back edge of the floor.
 13. Assemble wall panels 1-H and 1-I together using 2 short corner posts (part no. 5-30) and one corner post (part no. 5-31). Make sure the walls are at a 90° angle to each other.
 14. When the glue is dry, position the house on the base subassembly, as far to the right as possible with the rear corner posts flush with the back edge of the base as shown in Figure *16B.
 15. Glue the wing extension panels 1-H, 1-I to the front corner post joining wall panels 1-F and 1-G, as shown in Figure *16A.
 16. When the glue is dry, position the house on the base subassembly with the rear corner posts flush with the back edge of the base. The corner posts (part no. 5-1 and 5-2) on wall panel 1-A, should be flush to the right hand edge of the base.
 17. Mark the location of the house on the base with a pencil line around the inside and out side of the walls. Lift the house off the base.
- NOTE:** The hard wood flooring kit contains enough hardwood strips to cover one floor of the house. This material may alternatively be applied to door, stairways or used as wall paneling.
18. Brush contact cement on the base inside the pencil line that marks the location of the walls, and on one side of the hardwood strips. Follow the instructions provided with the contact cement.
- WARNING:** Contact cement is extremely volatile and flammable. The working area must be well ventilated. Keep well away from flame or sparks!!
19. Start laying hardwood strip at the front of the house and work toward the rear. Cut the strips with scissors. Off set the joints as shown in Figure *17.
 20. After the hardwood strips are in place burnish them down by rubbing them firmly with a small wood block.
 21. To achieve a pegged appearance, if desired punch the ends of each strip, as shown in Figure *17 using a 3/32 inch diameter nail set.
 22. Sand the flooring smooth and remove any traces of contact cement that would interfere with the positioning of the house on the base.
 23. Apply a bead of white woodworking glue between the two lines drawn in step 17. Carefully place the house into the bead of glue. Be careful to avoid getting any glue on the unfinished hardwood flooring. Lay weights on the upper floors to hold the house in position. Proceed immediately with step 24.
 24. Before the glue from step 23 dries, cut pieces of universal molding (part no. 5-3) to fit around the base of the walls on the inside and outside of the house. At the door ways, cut the molding a quarter-inch short to allow clearance for the door casing Figure *18.
 25. When the glue is dry, finish the hardwood flooring with two or three coats of satin sheen polyurethane varnish. Steel wool lightly between coats.

FIG. 15

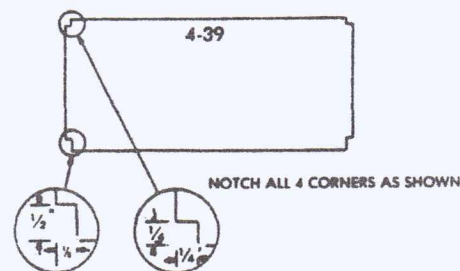
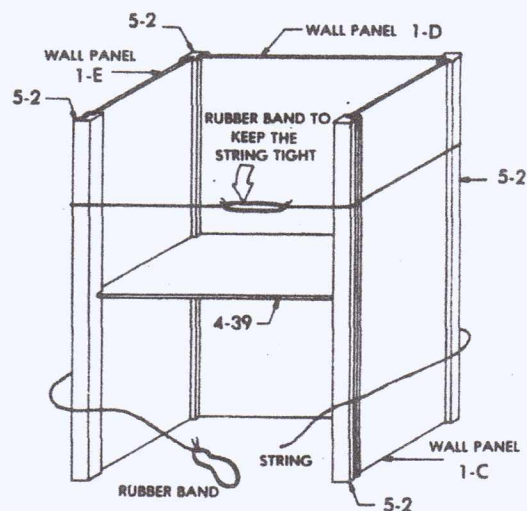

FIG. 16



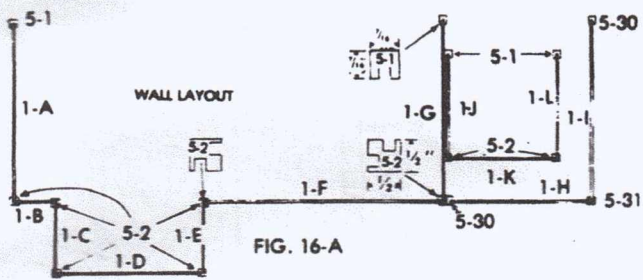

FIG. 16-A

FIG. 16-B

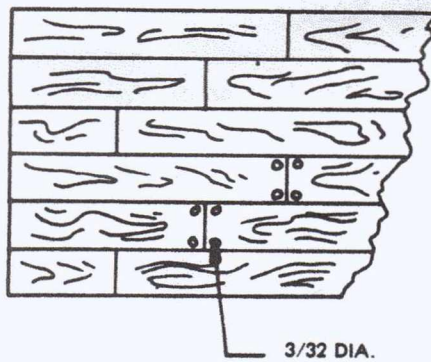
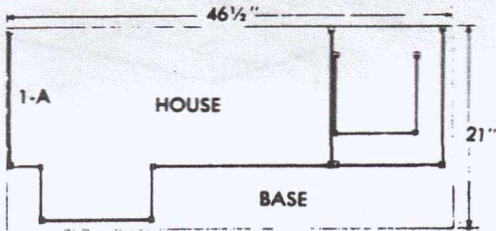

FIG. 17

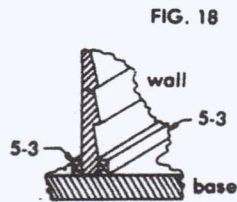

FIG. 18

3. Cut and attach floor support stock (part no. 5-46) as shown in Figure *19.
4. Assemble front deck (part 4-46) to side deck (part 4-45) by applying a bead of glue to the joint and pressing together firmly. Place on flat surface covered with waxed paper and allow the glue to dry.
5. Attach front deck trim (part 5-55) side deck trim (part 5-56) and rear deck trim (part 5-57) as shown in Figure *20.
6. Notch deck subassembly as required to fit around corner posts.
7. Apply a bead of glue to tops of floor support stock installed in step 3. Also apply a bead of glue to the top of wall panels 1-H and 1-I. Press deck subassembly into place and weight or pin into place and allow the glue to dry.
8. Place preassembled tower on the deck adjacent to and centered on wall panel 1-G glue tower assembly to deck and wall panel 1-G, making certain that walls are square.

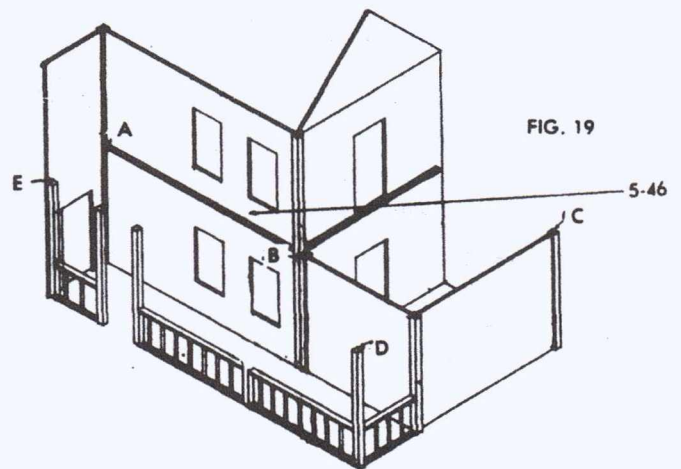

FIG. 19

FINAL ASSEMBLY PART 2 DECK AND TOWER INSTALLATION

1. Prepare your tools and materials. You will need the following items to complete this phase:
 - a dispenser of white woodworking glue
 - a pencil
 - a yardstick
 - a roll of waxed paper
2. Locate the parts. You will need the following parts and completed subassemblies:

floor support	5-46	1 piece
front deck	4-46	1 piece
side deck	4-45	1 piece
front deck trim	5-55	1 piece
side deck trim	5-56	1 piece
rear deck trim	5-57	1 piece
tower subassembly		

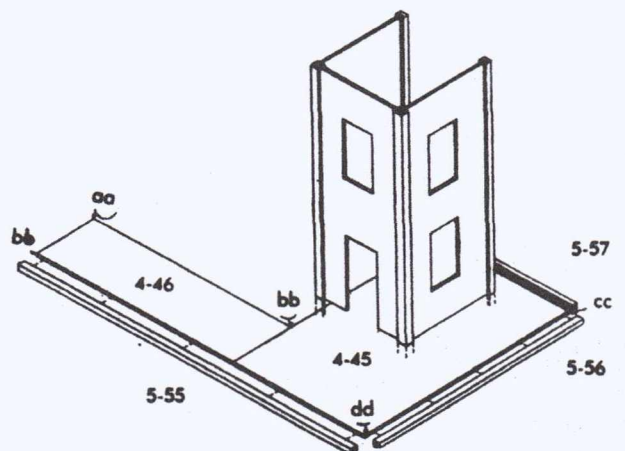

FIG. 20

**FINAL ASSEMBLY PART 3
PORCH RAILING AND FRONT
STEPS INSTALLATION**

1. Prepare your tools and materials. You will need the following items to complete this assembly:
 - a dispenser of white woodworking glue
 - a roll of waxed paper
 - masking tape
 - 100 grade (med.) sand paper
2. Locate the parts. You will need the following parts and completed subassemblies:

porch steps lower	6-7	1 piece
porch steps base	6-8	1 piece
railing post	6-6	4 pieces
porch railing	6-4	
deck railing corner posts	6-9	4 pieces

 completed railing assemblies.
3. Install porch railing and deck supports using measurements given in Figure *21. Make certain that deck supports and railings are vertical.
4. Install deck railing using the preassembled railings and deck railing corner post (part no. 6-9) as shown in Figure *21.
5. Slip a sheet of waxed paper under the base, directly in front of the doorway. Glue the porch steps (part no. 6-7 and 6-8) against the front edge of the base, centered in front of the doorway. As shown in Figure *22.
6. Cut two 3 1/4" lengths of porch railing stock (part no. 6-4) with the ends angled 60° degrees, as shown in Figure *22.
7. Glue the four posts (part no. 6-6) in place on the corners of the porch steps, then glue the railings on top of the posts Figure *22.

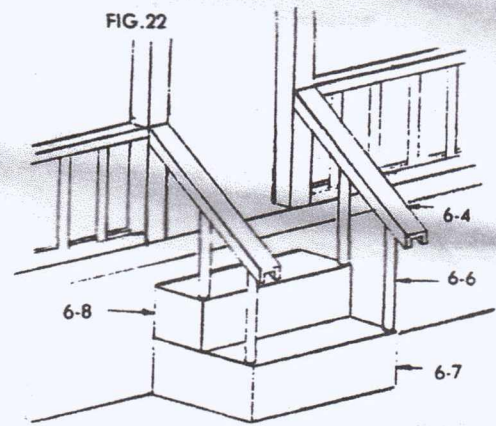
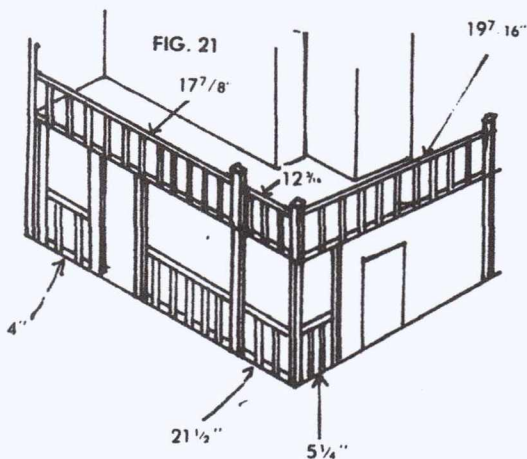

**FINAL ASSEMBLY PART 4
ROOF**

1. Prepare your tools and materials. You will need the following items to complete this assembly:
 - a dispenser of white woodworking glue
 - a sharp utility knife
 - masking tape
 - a ruler
 - a pencil
 - a framing square
2. Locate the parts. you will need the following parts:

4-8 rear roof panel	1 piece
4-19 rear roof panel	1 piece
4-22 side wing roof panel	2 pieces
4-23 front wing roof panel	1 piece
4-42 main roof panel	1 piece
4-43 tower roof	4 pieces
5-36 wing deck	1 piece
5-39 tower roof block	4 pieces
5-54 ridge cap	1 piece
5-95 fillet molding	1 piece
6-4 porch railing	
6-10 wing roof deck corner posts	2 pieces
6-11 railing posts	
3. Lay out all roof panels as shown in Figure *23 and draw lines starting 1 1/4" up from the bottom edge, the rest of the lines are spaced at 1" intervals.
4. Glue the ridge cap (part no. 5-54) across the top edge of the front roof panel.
5. When the glue from step 3 is dry, prop the front roof assembly in a vertical position with the ridge cap lying on the table, as shown in Figure *24. Glue the rear roof panels (part 4-8 and 4-19) in place, rough side down. Make certain that the front and rear roof panels join at 90° degree angles to one another.

6. Glue the fillet molding (part no. 5-95) across the front edge of the attic floor, exactly flush with the front wall panels. Be sure it is sloped the same way as the gables.
7. Trim the tops of the corner posts on the main house structure as required to insure that the roof assembly will fit tightly against the gable ends.
8. When the glue from step 5 is dry, apply glue to the tops of the gable ends, the gable end supports, and the fillet molding. Carefully position the roof assembly on the house.
9. Attach tower roof blocks (part no. 5-39, 4 pieces,) to tower roof (part no 4-43 2 pieces). Make certain that these blocks are placed $1\frac{1}{2}$ " from the peak.
10. After the glue from step 9 has dried, attach the two remaining tower roofs to complete the sub-assembly. Allow to dry.
11. Trim corner posts 5-1 and 5-2 at an angle to allow tower roof to fit snugly on wall panels. Attach tower roof assembly to tower walls with woodworking glue applied to the top of wall panels and corner posts.
12. Attach side wing roof panels (part no. 4-22 2 pieces and 4-23 1 piece) to wing roof deck (part no. 5-36) as shown in Figure *25. Trim corner posts 5-1 and 5-2 so that the roof assembly will fit snugly on top of wall panels. Make certain that eaves align with the main roof. Apply white glue to all contact points including valley intersections.
13. Assemble the porch railing as previously outlined and assemble railing and deck corner posts (part no. 6-10 2 pieces) as shown in Figure *25.
14. Using plain shakes (part no. 5-17), shake all roof panels, using guide lines drawn in step 3.
15. Using plain shakes (part no. 5-17) and fancy shakes (part no. 5-18), shake all exposed surface on gable end attached to wall panel 1-G.

FIG. 23

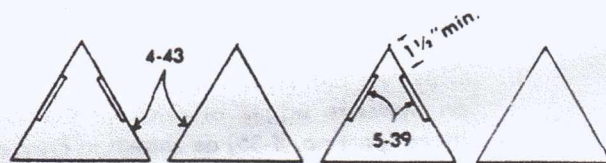
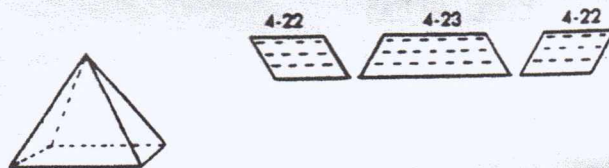

FIG. 24

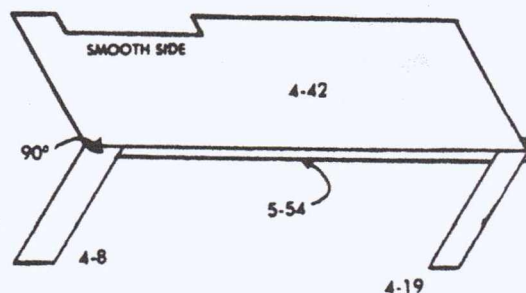

FIG. 25

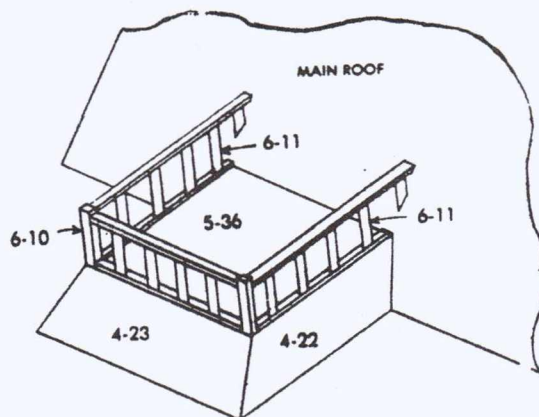
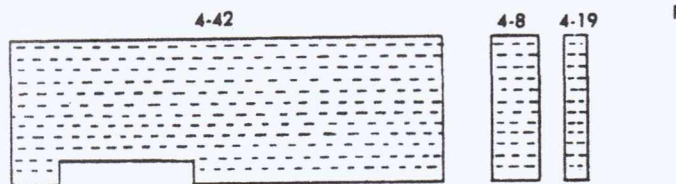
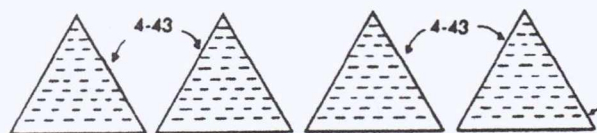

FIG. 23



ALL ROOF PANELS SHOWN ROUGH SIDE UP



FRIST LINE DRAWN $1\frac{1}{2}$ " ALL OTHER LINE AT 1" INTERVALS

FINAL ASSEMBLY PART 5 PARTITIONS

1. Prepare your tools and materials. You will need the following items to complete this phase.
 - a dispenser of white woodworking glue
 - a sharp utility knife
 - a ruler
 - a pencil
2. Locate the parts. You will need the following parts:

4-4 attic partition	1 piece
4-35 room partitions	3 pieces
5-41 partition trim	6 pieces
5-48 attic partition trim	1 piece
3. Glue two pieces of partition trim (part no. 5-41) on opposite edges of each of the room partitions (part no. 4-35) as shown in Figure *26.
4. Trim the top of the attic partition trim as required to fit under the roof.
5. Determine where you want to put the partitions to create a floor plan you like. Measure and mark the locations, top and bottom, to insure that the partitions are installed straight and vertical.
6. Apply glue to the tops and bottoms of the partitions and install them in the positions marked.

FIG. 26

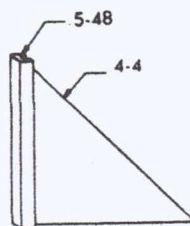
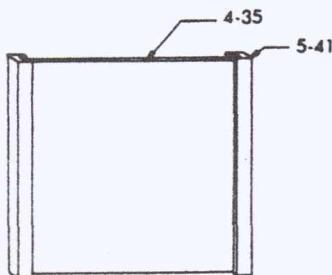

FINAL ASSEMBLY PART 6 DOOR AND STAIRWAYS

1. Prepare your tools and materials. You will need the following items to complete this phase:
 - a dispenser of white woodworking glue
 - masking tape
 - 100 grade (med.) sandpaper
 - a sharp utility knife
2. Locate the parts. You will need the following parts and completed subassemblies:

2-5 door top casing	6 pieces
2-7 decorative emblems	18 pieces
2-26 door	3 pieces
5-3 universal molding stock	
hinge pins, (brads)	6 pieces
door knobs (map pins)	3 pieces
stairway subassembly,	2 pieces
3/4 inch railing subassemblies,	4 pieces
3. Review the instructions and verify that all steps have been completed.
4. Prefit the stairway subassemblies into the house. If the wall trim prevents the stairway from fitting tightly against the partition, cut a notch out of the side of the stairway to provide the necessary clearance. Sand off any glue or other protrusions that interfere with the fit of the stairways.
5. Apply glue to the edge of the stairway assembly that attaches to the wall, and across the top and bottom of the assembly where it contacts the stairwell and floor.
6. Place the stairway assembly in position, taking care to keep glue from getting on the hardwood floor except where the stairway attaches.
7. Once the stairway glue has set, install the stair railing subassemblies as shown in Figure *27.
8. Lay out the decorative emblems (part no. 2-7) on the doors (part no. 2-26) in a pattern that creates an effect you like. (The standard pattern is shown in Figure *28). Glue them in place.
9. Cut 6 pieces of universal molding (part no. 5-3) to fit in the tops and bottoms of the three doorways.
10. If the glue is dry from step 8, use sandpaper to round off the hinged edge of the door, as shown in the detail circle.
11. Drive a hinge pin through each of the 6 pieces of universal molding, 5/16 inch from one end.

12. Hold the piece of universal molding with the hinge pin through it so that the hinge pin goes into the door $\frac{1}{4}$ inch from the rounded edge, as shown in Figure *28. Install the four pieces on the tops and bottoms of both doors in this manner.
13. Install the door knob pins as shown.
14. At the top and bottom of each door, insert several paper shims between the door and the universal molding. This will ensure that the door will have proper clearance for opening and closing.
15. Apply glue to the universal molding pieces, then insert the door assembly into the door opening. Be sure the door has adequate clearance at the sides.
16. After the glue has dried, remove the paper shims.
17. Cut pieces of universal molding stock (part no. 5-3) and install it as base molding along the room partitions and around the second floor walls.

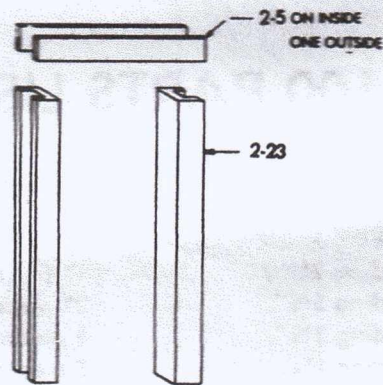

FIG. 28

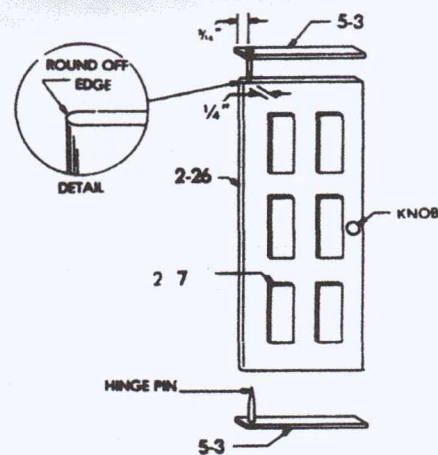
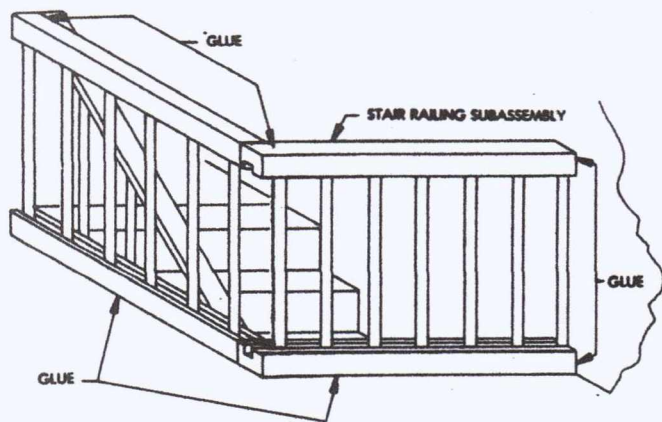

FIG. 27



CONGRAULATIONS.. Your miniature house is fully assembled.

VH—600 PARTS LIST

1-2.	siding 14"	12 pieces,
1-3.	siding 8 1/4"	28 pieces,
1-4.	siding 3"	30 pieces,
1-5.	siding 2 3/4"	17 pieces,
1-6.	siding 5 1/2"	39 pieces,
1-8.	siding 2 1/2"	4 pieces.
1-9.	siding 1 1/2"	8 pieces
1-11.	siding 2"	30 pieces
1-16.	siding 18 1/2"	6 pieces
1-17.	siding 11"	9 pieces
1-28.	siding 9 1/2"	6 pieces

Siding

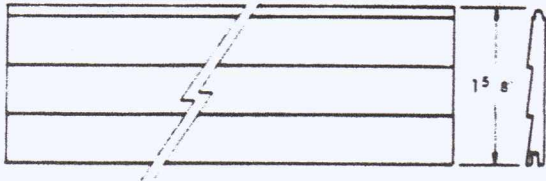

2-5 Top & Bottom Window Casing 50 pieces,
Top Door Casing

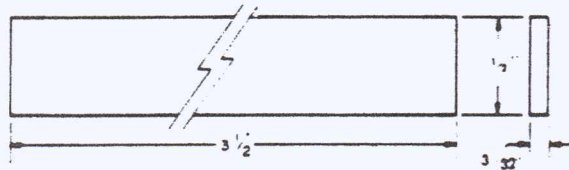

2-7 Decorative Emblems 18 pieces

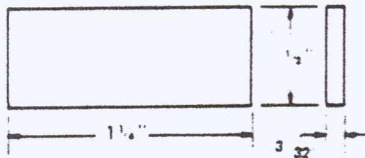

2-22 Window Side Casings 28 pieces



2-23 Door side Casings 8 pieces

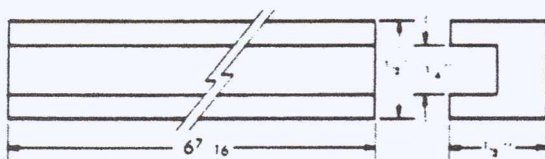

2-26 Door

3 pieces

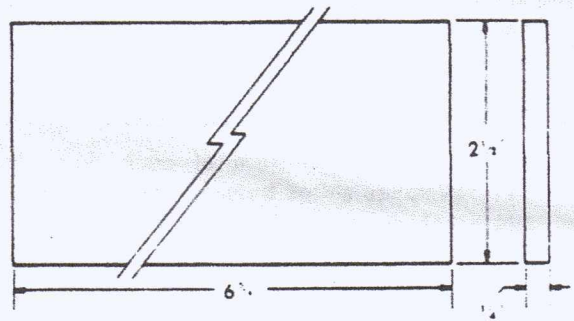

2-29 Inside Window Trim

28 pieces

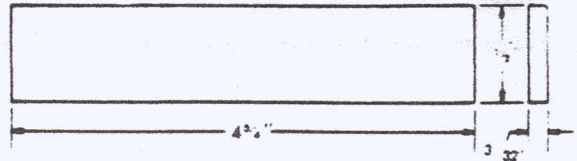

2-30 Top & Bottom Window Frame 28 pieces.

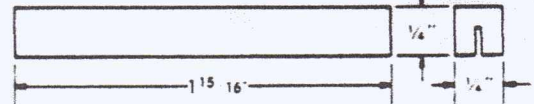

2-33 Window Cap

17 pieces

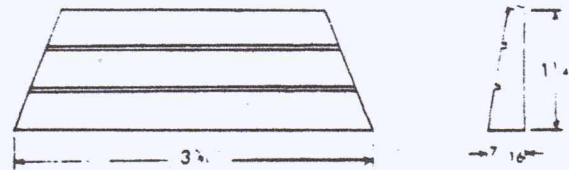

3-2 Base

1 piece

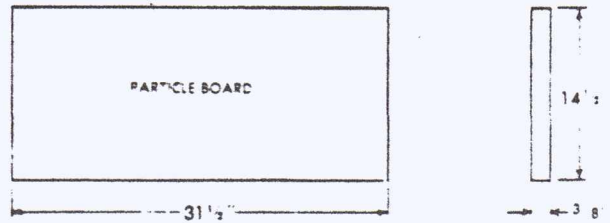

3-3, Front Base

1 piece

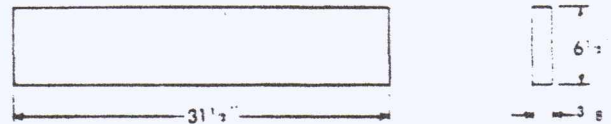

3-6, Foundation Strip

3 pieces

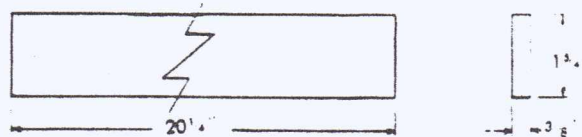

3-12, Side Base 1 piece

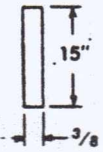
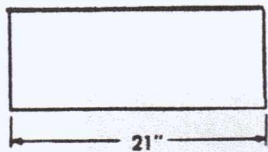

4-35, Room Partitions 3 pieces

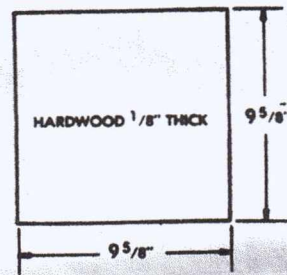

3-13 Foundation Strip 4 pieces

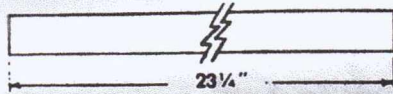

4-36, Main gable 2 pieces

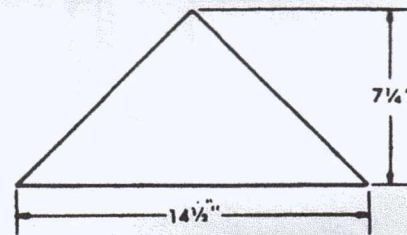

4-4, Attic Partition 1 piece

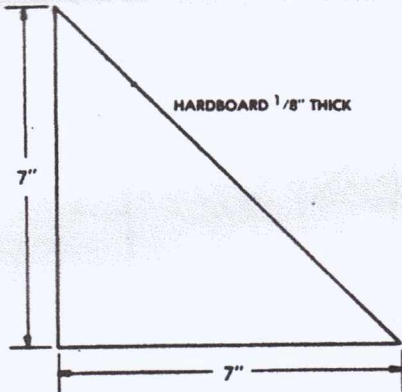

4-37 Floor 2 pieces

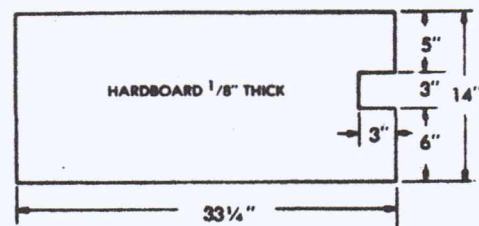

4-8, Rear Roof Panel 1 piece

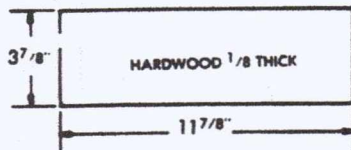

4-39, Front wing floor 1 piece

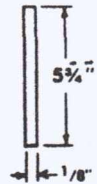
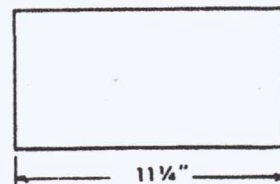

4-19, Rear roof panel 1 piece

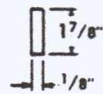
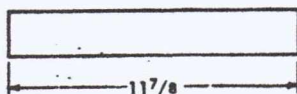

4-42 Main Roof Panel 1 piece

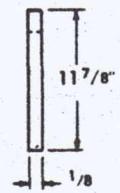
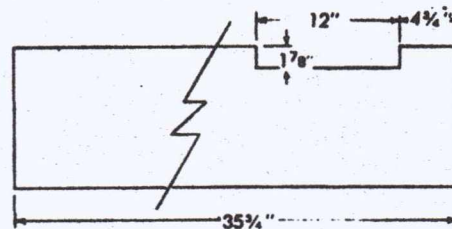

4-22 Side wing roof 2 pieces

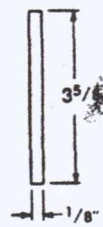
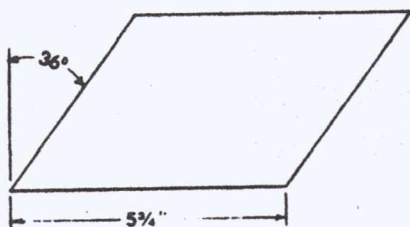

4-23 Front wing roof panel 1 piece

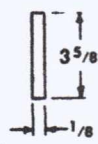
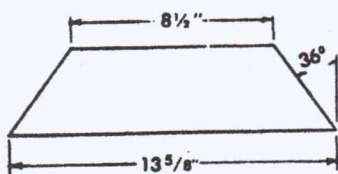

4-43 Tower Roof 4 pieces

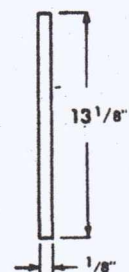
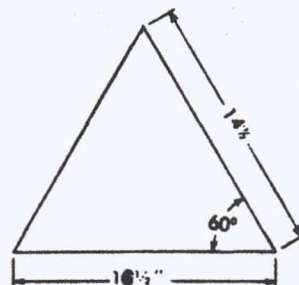

4-44 Tower Floor

1 piece

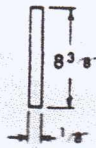
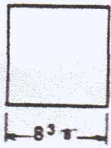

5-18 Shakes (fany)

1 bag

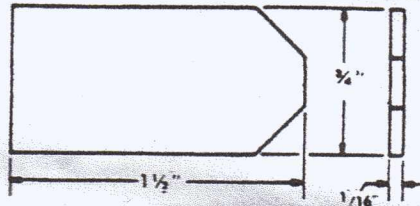

4-45 Deck side floor

1 piece

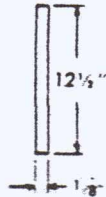
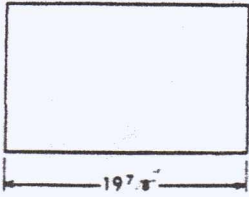

5-19 Universal Shake trim

9 feet

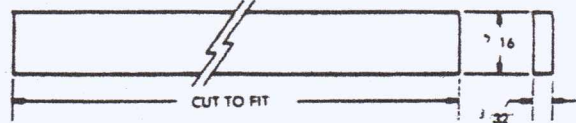

4-46 Deck front floor

1 piece

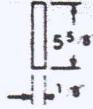
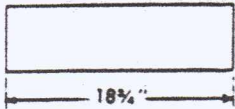

5-26 Chimney stack

1 piece

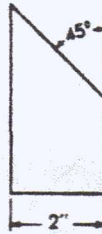

5-1 Rear corner posts

4 pieces

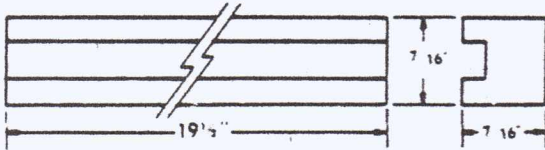

5-28 Chimney top

1 piece

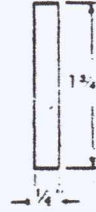
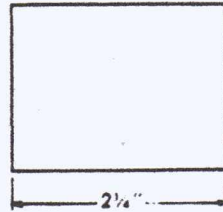

5-2 Front corner posts

8 pieces

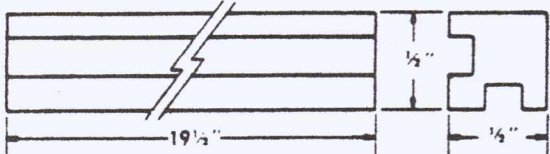

5-30 Short corner post

2 pieces

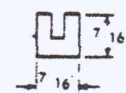
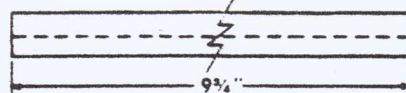

5-3 Universal moulding stock

54 feet

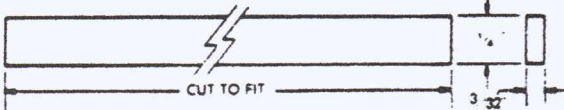

5-31 Short corner post

1 piece

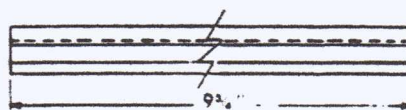

5-17 Shakes (plain)

1 bag

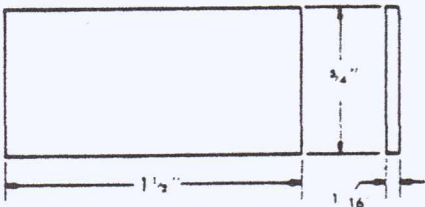

5-36 Wing roof and deck

1 piece

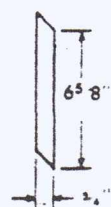
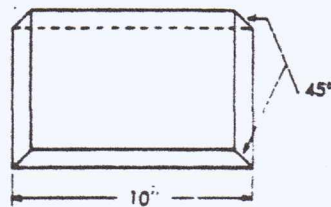

5-37 Deck supports 6 pieces

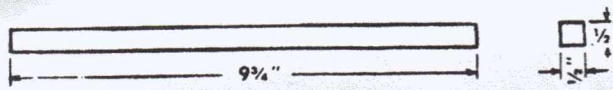

5-39 Tower roof block 4 pieces

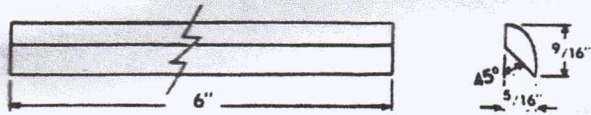

5-41 Partition trim 6 pieces

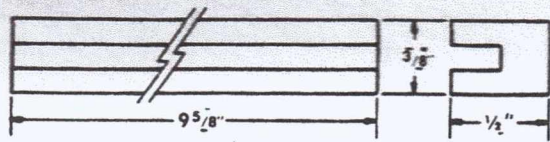

5-46 Floor support 21 feet

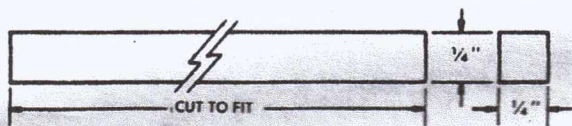

5-47 Main gable support 4 pieces

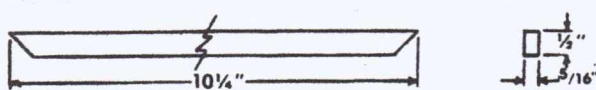

5-48 Attic partition trim 1 piece

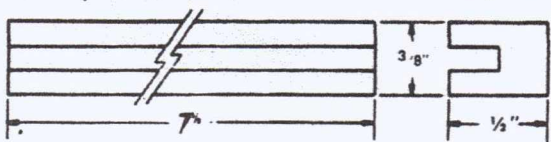

5-49 Window divider Stock 18 feet

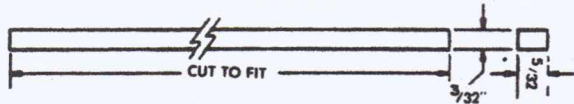

5-51 Rear floor trim 2 pieces

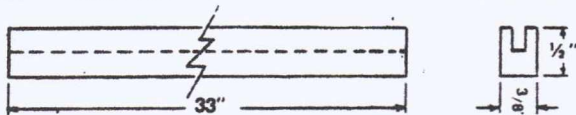

5-54 Ridge Cap 1 pieces

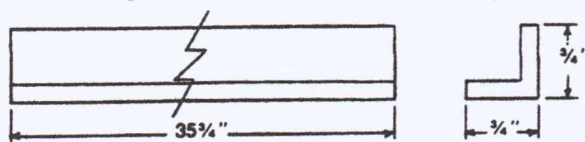

5-55 Second floor front deck trim 1 piece

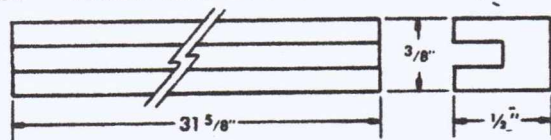

5-56 Second floor side deck trim 1 piece

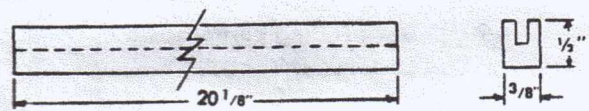

5-57 Second floor rear deck trim 1 piece

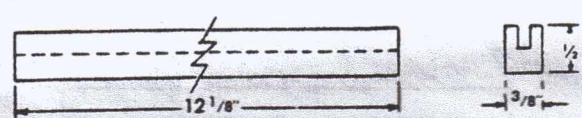

5-58 Tower floor trim 1 piece

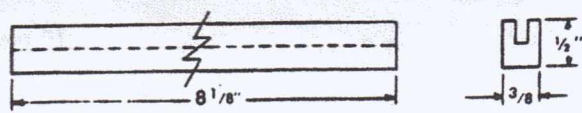

5-70 Bannister Stock 6 feet

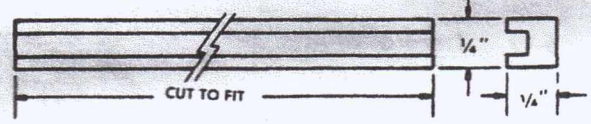

5-95 Fillet moling 1 piece

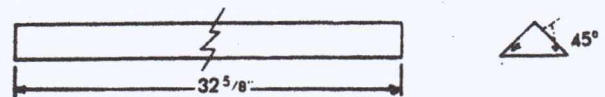

6-2 Bannister Post 60 pieces

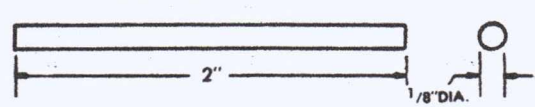

6-4 Porch railing stock 18 feet

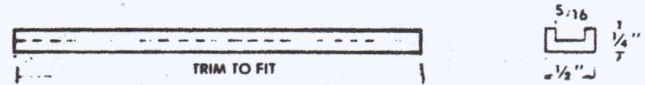

6-6 Porch railing posts 76 pieces

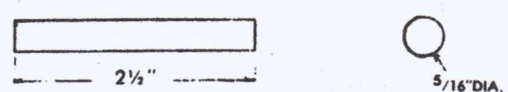

6-7 Porch step, lower 1 piece

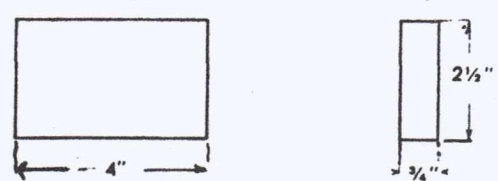

6-8 Porch step, base 1 piece



6-9 Deck railing cornerposts 4 pieces

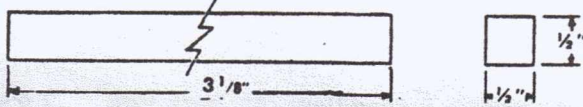

6-10 Wing roof deck corner posts 2 pieces

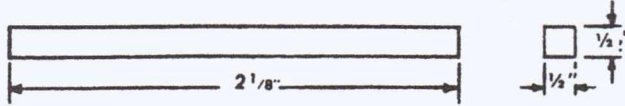

6-11 Dowels 18 pieces

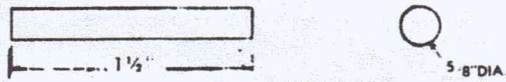

6-12 Decorative gussets 6 pieces



6-13 Stairway base 2 pieces

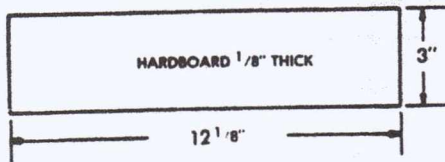

6-14 Steps 26 pieces

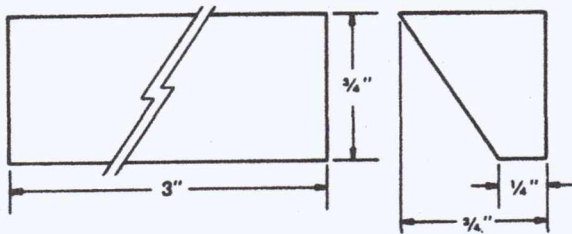

- 6-17 Door knob 3 pieces
- 6-18 Hinge pins (1/2 inch brads) 6 pieces
- 6-19 Hardwood Flooring 1 package
- 6-20 Window pane 23/16 X 47/16 14 pieces.